

Section

I

Selection GuideL-2

- PS5R Slim Line Series
 - DIN Rail Switching L-3
- PS5R Standard Series
 - DIN Rail Switching L-8
- PS3L Series
 - Metal Frame Switching..... L-13

Power Supplies



New
120W & 240W Slim Line
Power Supplies now available.
See page L3.

for more information on this product family visit
www.idec.com/powersupply







Additional Web Resources

- New and updated product information
- Downloadable software demos & upgrades
- Part configuration tool & cross reference
- Online stock check & ordering
- IDEC field sales & distributor search
- Online literature request
- Downloadable manuals & CAD drawings
- Manufacturer's suggested retail price list
- Product training schedule & locations
- Advertising & trade show schedules
- Press releases & FAQs

www.idec.com/powersupply

Selection Guide

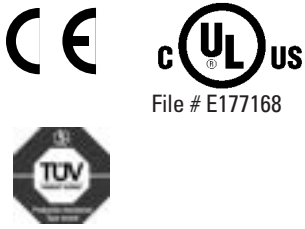
	PS5R Slim Line	PS5R	PS3L
Appearance			
Page	L-3	L-8	L-13
Housing	Plastic	Plastic	Metal
Mounting	DIN Rail or surface mount	DIN Rail or surface mount	"L" bracket or DIN rail bracket
Wattage Range	30W to 240W	7.5W to 240W	10W to 300W
Input Voltage	30W to 90W: 85 to 264 VAC, 100-370 VDC 120W & 240W: 85 to 264 VAC, 100-350 VDC	100 to 240VAC nominal, (85 to 264VAC), 47 to 63 HZ 110-340VDC nominal (105 to 370VDC)	100 to 240VAC nominal, (85 to 264VAC), 47 to 63 HZ (105 to 350VDC)
Output Current Ratings	5VDC - 12VDC 2.5A 24VDC 1.3A, 2.5A, 3.75A, 5A, 10A	1.5A, 2.5A 0.6A, 1.2A, 2.5A 0.30A, 0.60A, 1.3A, 2.1A, 3.1A, 4.2A, 5A, 10A	2A, 3A, 6A 0.90A, 1.4A, 2.5A, 4.3A, 8.4A, 13A 0.50A, 0.70A, 1.3A, 2.2A, 4.5A, 6.5A, 12.5A
Typical Efficiency	12VDC 78% 24VDC 80% to 84%	73% to 75% 75% to 85%	74% to 80% 78% to 82%
Voltage Adjustments	+/-10%	+/-10% (V.ADJ control on front)	+/-10% (V.ADJ control on front)
Ripple Voltage	up to 2% peak to peak max (including noise)	2% peak to peak max (including noise)	160mV maximum
Over Voltage Protection (input)	120% or more, auto reset	120% typical	120% typical
Over Current Protection (output)	105% min shutdown	105% minimum (Zener or auto reset)	105% minimum (Zener or auto reset)
Operating Temperature	-10° to +60°C (14° to 140°F)	-10° to +60°C (14° to 140°F)	-10° to +60°C (14° to 140°F)
Vibration Resistance	10 to 55 Hz Amplitude 0.375mm	45m/s ² (approximately 4.5G) 10 to 55hz, 2 hours on each of 3 axes	20m/s ² (approximately 2G) 10 to 55hz, 1 hour on each of 3 axes
Shock Resistance	300m/s ² , 3 times each 6 axes	294m/s ² , 3 shocks on each of 6 axes	200m/s ² , 1 shock on each of 3 axes
Weight (approximate)	250g to 1000g (depending on model)	150g to 2000g (depending on model)	240g to 1550g (depending on model)
Termination	M3.5 phillip/slotted, spring loaded, captive (fingersafe)	M3.5 phillip/slotted, spring loaded, captive (fingersafe)	IEC Style screw terminals (fingersafe)
Approvals	EMC Directive EN61204-3:2000 (EMI: Class B, EMS Industria) UL508, UL1604	EMC Directives EN50081-2 and EN50082-2. LVD Directives EN60529 and EN60950. UL508	
			

Power Supplies

PS5R Slim Line Series — Switching Power Supplies



Designed with Accessibility and Convenience in Mind

DC Low Indicator

(120W & 240W Slim Line Only)

The indicator turns on when the output voltage drops below 20V DC. This assists troubleshooting power supply problems.

DC ON Indicator

The indicator turns on when the unit is powered up. This is a convenient way to know when the power supply is receiving power.

Output Voltage Adjustment

The output voltage can be easily adjusted within +10% of the rated voltage.



Fingersafe, Spring-up Screw Terminals

Never worry about losing screws or getting an inadvertent shock from a terminal. The terminals are captive spring-up screws, which makes using them as easy as pushing a screw down and tightening it. They are shock and vibration resistant, and work with ring lugs, fork connectors or stripped wire connections. The terminals are rated IP20 which means when tightened, they are recessed to keep finger and objects from touching the input contacts.

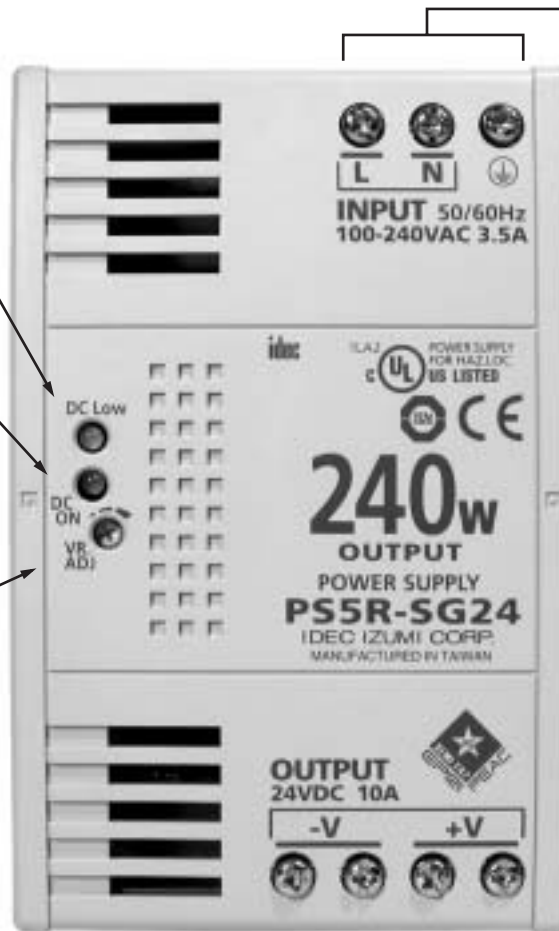

Universal Inputs

The power inputs have a range of 85-264V AC to 100-370V DC, and automatically adjust to the correct input power. This makes IDEC power supplies suitable for use anywhere in the world. Power factor correction has also been included to minimize harmonic distortion, resulting in a longer operating life and increased reliability.

Long Life Expectancy

IDEC power supplies are very reliable, with a life expectancy of 70,000 hrs. (minimum) or longer, depending on usage.

Output Channel

With very low output ripples of less than 1% peak to peak, the 120W and 240W power supplies are some of the best in the industry. The output comes with overload protection that avoids damaging the power supply. The 240W power supply also has the convenience of two output sets of output screws for wiring.

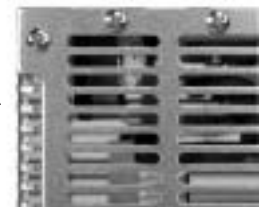

Ventilation Grill

Provides cooling for the power supply and prevents small objects from falling into the power supply circuitry.

Features & Part Numbers



Key features of the PS5R Slim Line series include:

- Lightweight and Compact in size
- Wide Power Range: 30W – 240W
- Universal Input:
30W to 90W:85-264V AC/100-370V DC
120W and 240W:85-264V AC/100-350V DC
- Power Factor Correction (EN61000-3-2) for 60W to 240W
- Meets SEMI F47 Sag Immunity (120W & 240W)
- NEC Class 2 rated (30W & 60W)
- Approved for Class 1, Div. 2 Hazardous Locations
- Fused input
- Overcurrent protection, auto-reset
- Overvoltage protection, shut down
- Spring-up Screw Terminal type, IP20
- DIN rail or Panel Surface Mount
- Approvals:
CE Marked
TÜV
c-UL, UL 508
UL 1310 (PS5R-SC, -SD)
UL 1604
EN 50178:1997
LVD: EN60950:2000
EMC: Directive EN61204-3:2000
(EMI: Class B, EMS: Industrial)



File # E234997



(SEMI F47 120W & 240W only)

Part Numbers

Part Number	Item	Watts	Rated Voltage	Rated Current
PS5R-SC12		30	12V DC	2.5A
PS5R-SC24			24V DC	1.3A
PS5R-SD24		60	24V DC	2.5A
PS5R-SE24		90	24V DC	3.75A
PS5R-SF24		120	24V DC	5A
PS5R-SG24		240	24V DC	10A

L

Power Supplies

Specifications

Part Numbers	12VDC output	PS5R-SC12	-	-	-	-	
	24VDC output	PS5R-SC24	PS5R-SD24	PS5R-SE24	PS5R-SF24	PS5R-SG24	
Output Capacity		30W	60W	90W	120W	240W	
Input	Input Voltage (single-phase, 2-wire)	85 to 264 VAC, 100 to 370 VDC			85 to 264V AC, 100 to 350V DC		
	Input Current (typical)	100VAC	0.9A	1.7A	2.3A	1.8A	3.5A
		200VAC	0.6A	1.0A	1.4A	1.0A	1.7A
	Internal Fuse Rating		3.15A	3.15A	4A	4A	6.3A
	Inrush Current (cold start)	50A maximum (at 200V AC)					
	Leakage Current (at no load)	0.75mA maximum			1mA maximum		
	Typical Efficiency	12VDC	78%	-	-	-	-
24VDC		80%	83%	82%	84%		
Output Current Ratings	12VDC	2.5A	-	-	-	-	
	24VDC	1.3A	2.5A	3.75A	5A	10A	
Voltage Adjustment	±10% (V. ADJ control on front)						
Output Holding Time	20ms minimum (at rated input and output)						
Starting Time	-	-	-	-	650ms maximum	500ms maximum	
Rise Time	100ms maximum (at rated input and output)			200ms maximum			
Line Regulation	0.4% maximum						
Load Regulation	1.5% maximum					0.8% max	
Temperature Regulation	0.05% degree C maximum						
Ripple Voltage	2% peak to peak maximum (including noise)				1% peak to peak maximum (including noise)		
Overcurrent Protection	105% or more, auto reset			103 to 110%, auto reset	105 to 130%, auto reset		
Overvoltage Protection	120% min. SHUTDOWN						
Parallel Operation	No	No	No	No	No	No	
Dielectric Strength	Between Input and Ground: 2000 VAC, 1 minute*						
Insulation Resistance	Between Input & Output Terminals: 100 MΩ Min						
Operating Temperature	-10 to 60°C (14 to 140°F)						
Storage Temperature	-25 to 75°C (-13 to +167°F)						
Operating Humidity	20 to 90% relative humidity (no condensation, no freezing)						
Vibration Resistance	Frequency 10 to 55Hz, Amplitude 0.375mm						
Shock Resistance	300m/s ² 3 times each in 6 axes						
Approvals	EMC: EN61204-3 (EMI: Class B, EMS: Industrial), LVD: EN60950, EN50178:1997, UL 1604, UL 508, UL1310 (PS5R-SC, -SD), c-UL (CSA 22.2 No. 14)						
	-				SEMI F47		
Harmonic Directive (EN61000-3-2)	N/A			EN61000-3-2 A14 class A			
Weight (approx.)	250g	285g	440g	630g	1000g		
Terminal Screw	M3.5 slotted-Phillips head screw (screw terminal type)						
IP protection	IP20 fingersafe						
Dimensions H x W x D (mm)	95 x 36 x 108			115 x 46 x 121	115 x 50 x 129	125 x 80 x 149.5	
Dimensions H x W x D (inches)	3.74 x 1.42 x 4.25			4.53 x 1.81 x 4.76	4.53 x 1.97 x 5.08	4.92 x 3.15 x 5.89	



1. For dimensional drawings, see page L-7.
2. *Between input and output: 3000VAC, 1 minute; Between output and ground: 500VAC, 1 minute

Temperature Derating Curves

PS5R-SC

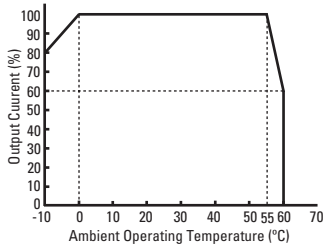

PS5R-SD, -SE, -SF

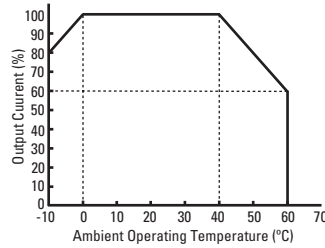

PS5R-SG

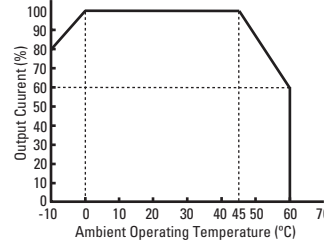

Condition Natural Air Cooling (Operating Temperature means temperature in surrounded PS5R.)

Make sure of convection in consideration of sufficient heat radiation. Do not block the opening of the switching power supply.

Keep at least 20mm clearance around the switching power supply, except for the opening.

All IDEC power supplies are listed to UL 508 which allows operation at 100% capacity inside a panel. This eliminates the need to use oversize power supplies or utilize two power supplies derated 50% of their rated output.

The charts above show that the PS5R Slim 30W/60W/90W (at 55°C), 120W (at 40°C), and 240W (at 45°C) meet the ambient temperature required by the UL 508 and EN60950 standards to operate at an output current of 100%. The output current starts to derate beyond the required temperature.

A Mounting

Mounting Style A (standard)

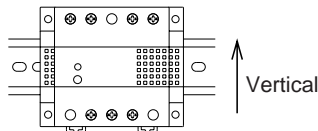

B Mounting

Mounting Style B (Facing upward)

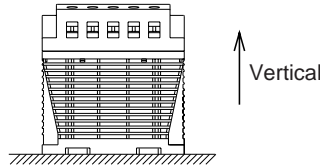

Accessories

PS5R-S Accessories

Appearance	Description	Part Number
	Panel Mounting Bracket for PS5R-SC and PS5R-SD	PS9Z-5R1C
	Panel Mounting Bracket for PS5R-SE	PS9Z-5R1E
	Panel Mounting Bracket for PS5R-SF & PS5R-SG	PS9Z-5R1G
	DIN rail (1000mm)	BNDN1000
	DIN rail end clip	BNL5

L

Power Supplies

Dimensions

PS5R-SC12 (30W) & PS5R-SD24 (60W)

Height 95.0 mm
 Width 36.0 mm
 Depth 108.0 mm

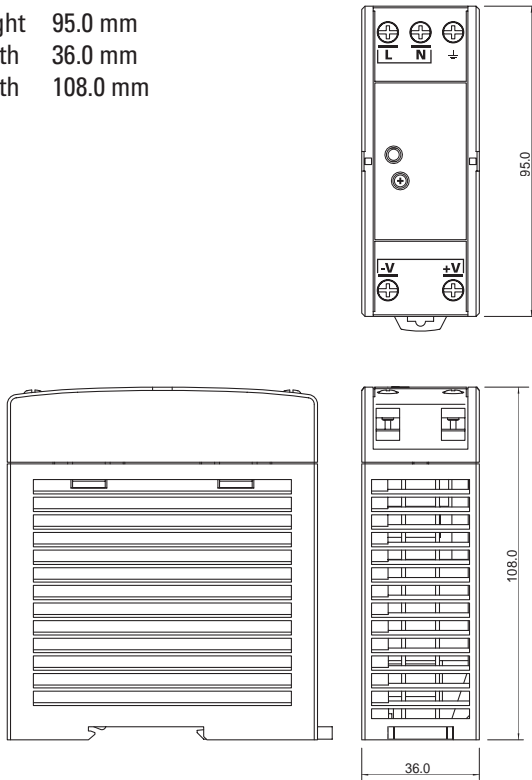

PS5R-SE24 (90W)

Height 115.0 mm
 Width 46.0 mm
 Depth 121.0 mm

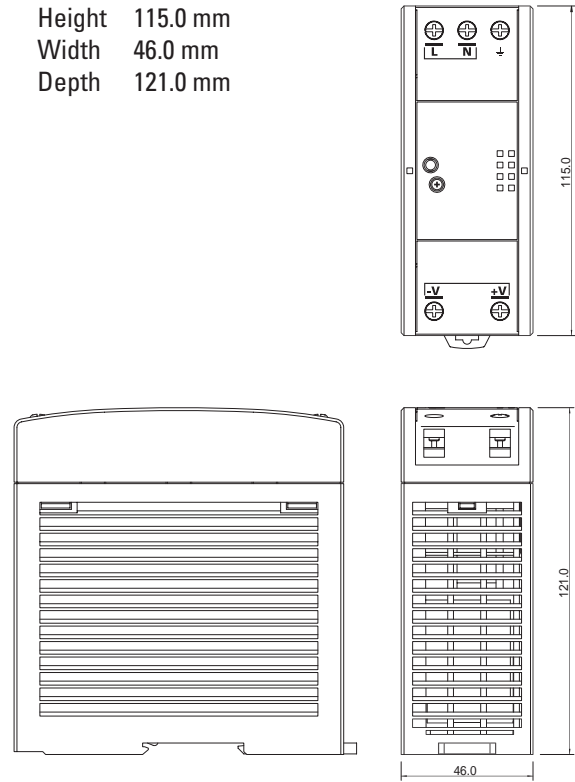

PS5R-SF24 (120W)

Height 115.0 mm
 Width 50.0 mm
 Depth 129.0 mm

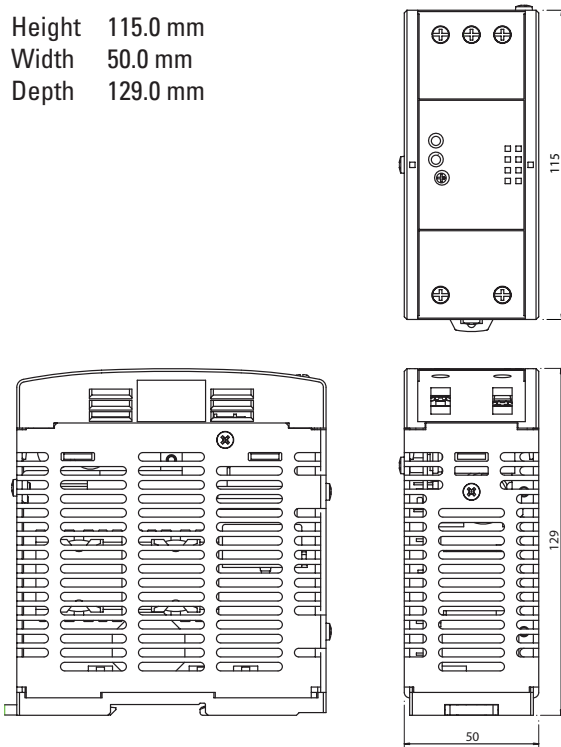

PS5R-SG24 (240W)

Height 125.0 mm
 Width 80.0 mm
 Depth 149.5 mm

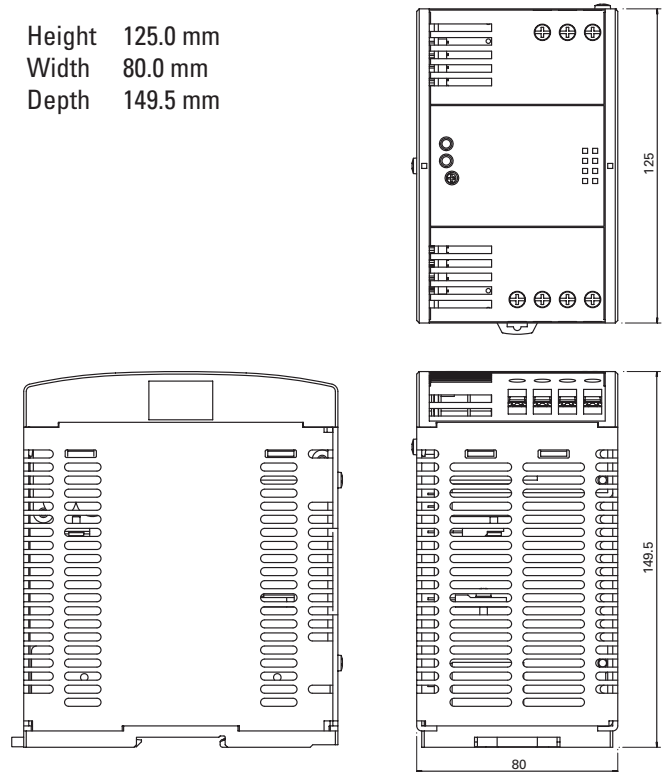

PS5R Standard Series — Switching Power Supplies



Key features of the PS5R standard series include:

- Wide Power Range: 7.5W-240W
- Universal Input:
7.5W-75W:85-264V AC/105-370V DC
100W:100-120V AC/200-240V AC
(Selectable) 240-370V DC
120W-240W:85-264V AC/105-370V AC
- Fused Input
- Overcurrent/Overvoltage Protection
- Power Factor Correction (75W, 120W, 240W models)
EN61000-3-3
EN61000-3-2
- Voltage adjustment + 10%
- Spring-up Screw Terminal, IP20 (finger-safe)
- DIN rail or Panel Surface Mount
- Approvals:
CE marked
UL 508 Listed
UL, c-UL
TUV approved
EMC Directives: EN50081-2
EN50082-2
EN61000-6-2
LVD EN60950:2000

L
Power Supplies



UL 508 Listed
File # E177168



Cert. No.
BL980213332392

Part Numbers

Part Number	Item	Watts	Rated Voltage	Rated Current
PS5R-A05		7.5	5V DC	1.5A
PS5R-A12			12V DC	0.6A
PS5R-A24			24V DC	0.3A
PS5R-B05		15	5V DC	2.5A
PS5R-B12			12V DC	1.2A
PS5R-B24			24V DC	0.6A
PS5R-C12		30	12V DC	2.5A
PS5R-C24			24V DC	1.3A
PS5R-D24		50	24V DC	2.1A
PS5R-Q24		75	24V DC	3.1A
PS5R-E24		100	24V DC	4.2A
PS5R-F24		120	24V DC	5A
PS5R-G24		240	24V DC	10A

Specifications

Part Numbers	5VDC output	PS5R-A05	PS5R-B05*	—	—	—	—	—	—	
	12VDC output	PS5R-A12	PS5R-B12	PS5R-C12	—	—	—	—	—	
	24VDC output	PS5R-A24	PS5R-B24	PS5R-C24	PS5R-D24	PS5R-Q24	PS5R-E24	PS5R-F24	PS5R-G24	
Output Capacity		7.5W	15W	30W	50W	75W	100W	120W	240W	
Input	Input Voltage (single-phase, 2-wire)	100 to 240VAC nominal (85 to 264V AC), 50/60Hz (47 to 63Hz) 110 to 340VDC nominal (105 to 370VDC)					100 to 120VAC, 50/60Hz 200 to 240VAC, 50/60Hz (jumper selectable) 240 to 370VDC		100 to 240VAC, 50/60Hz, 110 to 340VDC	
	Input Current (typical)	0.17A at 100VAC	0.3A at 100VAC	0.68A at 100VAC	1.15A at 100VAC	1.1A	2.5A at 100VAC 1.5A at 200VAC	1.8A	4A at 100VAC	
	Internal Fuse Rating	2A	2A	3.15A	3.15A	3.15A	4A	4A	6.3A	
	Inrush Current	50A maximum (at cold start at 200V AC)				70A maximum (at cold start at 230V AC)	50A maximum (at cold start at 200V AC)	70A maximum (at cold start at 230V AC)		
	Leakage Current (at no load)	0.75mA maximum (60Hz, measured in conformance with UL, CSA, VDE)								
	Typical Efficiency	69% at 5V 73% at 12V 75% at 24V	69% at 5V 75% at 12V 79% at 24V	75% at 12V 75% at 24V	79% at 24V	83% at 24V DC	85% at 24V	83% at 24V DC	83% at 24V	
	Oversvoltage Protection	Outputs turns off at 105% (typical)								
Output	Voltage and Current Ratings	5V, 1.5A 12V, 0.6A 24V, 0.3A	5V, 2.5A 12V, 1.2A 24V, 0.6A	12V, 2.5A 24V, 1.3A	24V, 2.1A	24V, 3.1A	24V, 4.2A	24V, 5A	24V, 10A	
	Voltage Adjustments	±10% (V.ADJ screw on top)								
	Output Holding Time	20ms minimum (at full rated input and output)								
	Rise Time	200ms maximum (at full rated input and output)								150ms max.
	Line Regulation	0.4% maximum								
	Load Regulation	1.5% maximum								
	Fluctuation due to Ambient Temperature Change	0.05% maximum								
	Ripple Voltage	2% peak to peak maximum (including noise)								
	Overload Protection	120% typical (Zener-limiting)			120% typical, auto reset					
Operation Indicator	LED									
Parallel Operation	PS5R-A	PS5R-B	PS5R-C	PS5R-D	PS5R-Q	PS5R-E	PS5R-F	PS5R-G		
	No				Yes		No	Yes		
Dielectric Strength	Between input and output terminals: 3,000V AC, 1 minute Between input terminals and housing: 2,000V AC, 1 minute Between output terminal and housing: 500V AC, 1 minute									
Insulation Resistance	Between input and output terminals/input terminals and housing: 100MΩ minimum (500V DC megger)									
Operating Temperature	-10 to +60°C (14° to 140°F) (see derating curves)									
Storage Temperature	-30 to +85°C (-22° to 185°F)									
Operating Humidity	20 to 90% relative humidity (no condensation)									
Vibration Resistance	45m/s ² , 10 to 55Hz, 2 hours on each of 3 axes				10 to 50Hz, 0.75mm p-p, 2 hrs on each of 3 axes					
Shock Resistance	300m/s ² (30G), 3 shocks in each of 6 directions									
Approvals	Conforms to EMC Directives EN50081-2 & EN50082-2. LVD Directive EN60529 — Certified to EN60950. UL508 listed. UL, c-UL, TUV approved. CE marked. EN61000-3-2									
Weight	150g	170g	360g	390g	800g	600g	1200g	2000g		
Termination	Spring-up, fingersafe terminals with captive M3.5 screws									
IP protection	IP20 (finger safe)									
Dimensions H x W x D (mm)	75 x 45 x 70	75 x 45 x 95	75 x 90 x 95	75 x 90 x 95	120 x 85 x 140	75 x 145 x 95	120 x 115 x 140	120 x 200 x 140		
Dimensions H x W x D (inches)	2.95 x 1.77 x 2.76	2.95 x 1.77 x 3.74	2.95 x 3.54 x 3.74	2.95 x 3.54 x 3.74	4.72 x 3.35 x 5.52"	2.95 x 5.71 x 3.74"	4.72 x 4.53 x 5.52	4.72 x 7.87 x 5.51		



1. For dimensional drawings, see page L-12.
2. For usage instructions, see page L-11.
3. *12.5W for 5VDC model.

Temperature Derating Curves

PS5R-A/B

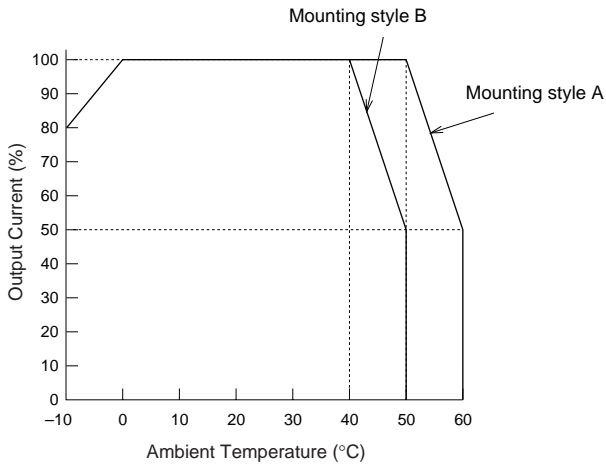

PS5R-C/D

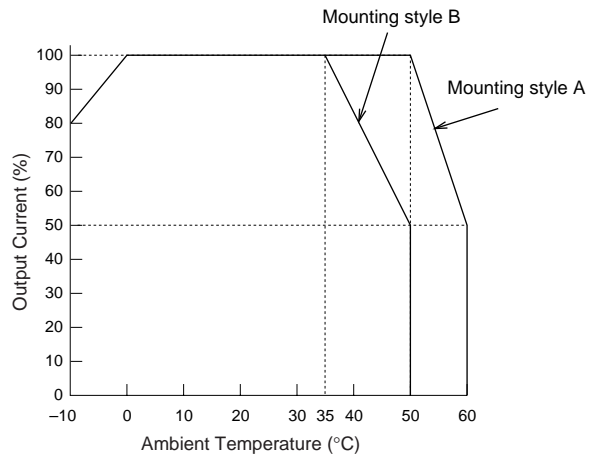

PS5R-E

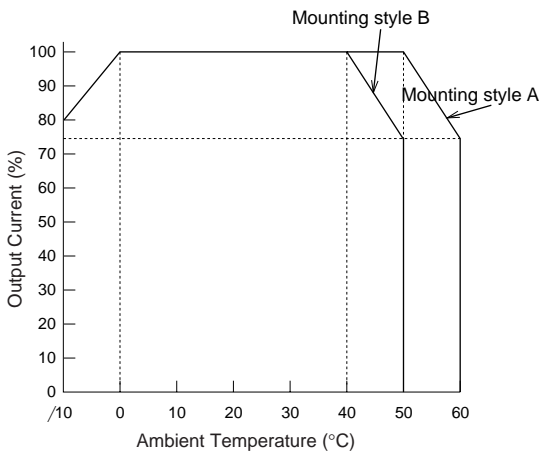

PS5R-Q

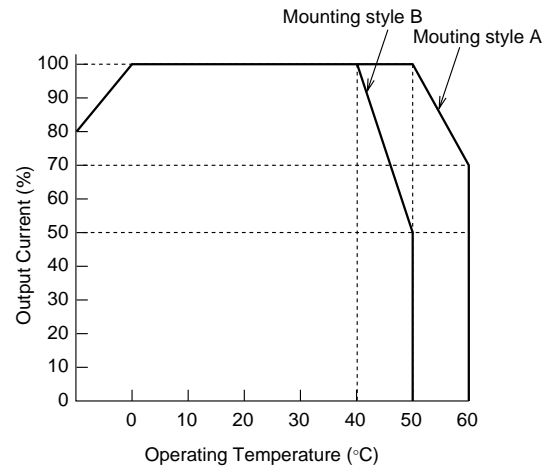

PS5R-F/G

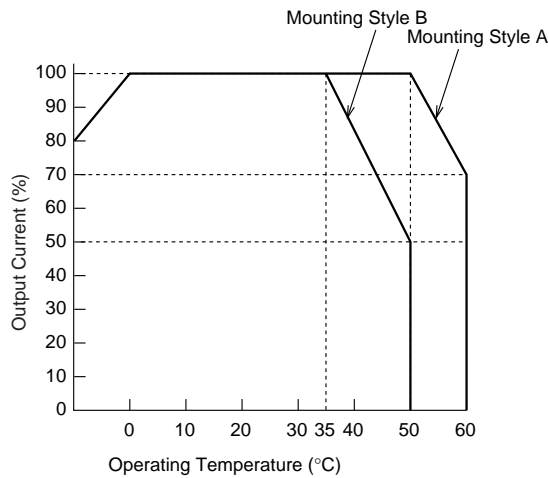

A Mounting

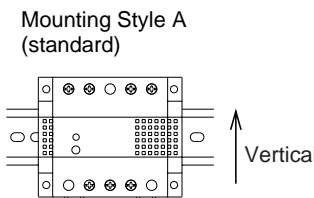

B Mounting

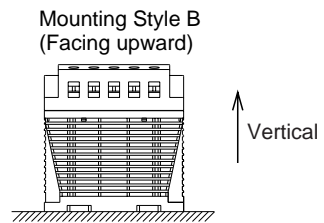



L

Power Supplies

Accessories

Part Numbers: PS5R Accessories

Appearance	Description	Part Number
	DIN rail (1000mm)	BNDN1000
	DIN rail end clip	BNL5

Installation Instructions

Time-Saving Spring-up Terminals

The innovative terminals on the PS5R series use a special, spring-loaded screw. This makes installation as easy as pushing down and turning with a screwdriver. Installation time is cut in half since the screws do not need to be backed out to install wiring. The screws are held captive once installed and are 100% finger-safe. Screw terminals accept bare wire or ring or fork connectors.

1. Insert the wire connector into the slot on the side of the power supply.
2. Using a Phillips screwdriver, push down and turn the screw.

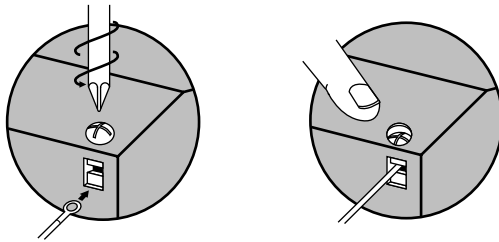

The wire is now connected, and the screw terminal is finger-safe!

Front Panel (terminals)

Terminal	Name	Description
V. ADJ	Voltage adjustment	Adjusts within $\pm 10\%$; turn clockwise to increase output voltage
DC ON	Operation indicator	Green LED is lit when output voltage is on
+V, -V	DC output terminals	+V: Positive output terminal -V: Negative output terminal
	Frame ground	Ground this terminal to reduce high-frequency currents caused by switching
L, N	Input terminals	Accept a wide range of voltages and frequencies (no polarity at DC input)
NC	No connection	Do <i>not</i> insert wires here, as this may damage the power supply

Overcurrent Protection Characteristics

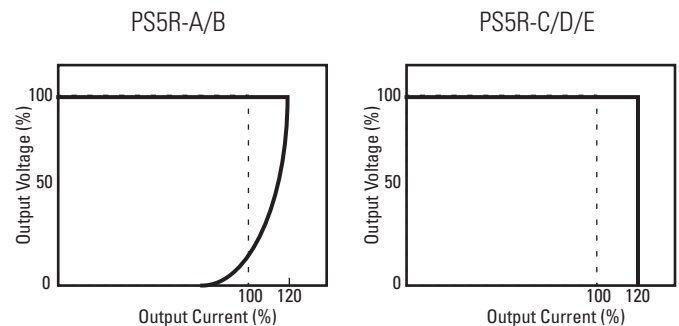

Parallel Operation

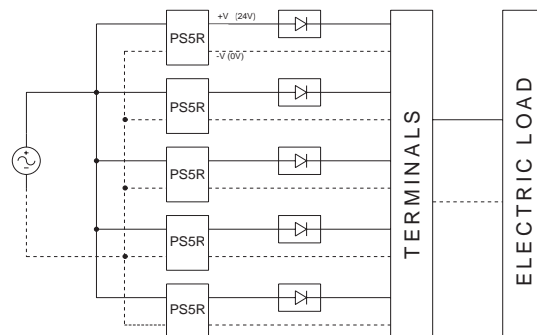

Parallel operation only recommended for PS5R-Q24, PS5R-F24 and PS5R-G24.

Dimensions

PS5R-A (7.5W)

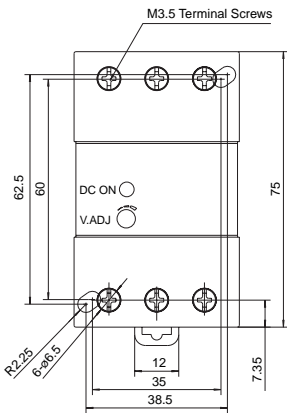

Height 75.0 mm
Width 45.0 mm
Depth 70.0 mm

PS5R-B (15W)

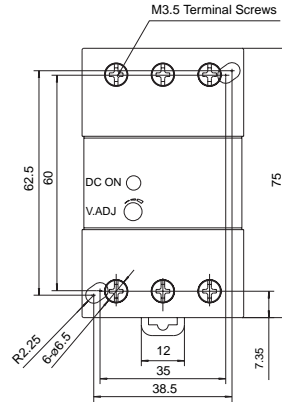

Height 75.0 mm
Width 45.0 mm
Depth 95.0 mm

PS5R-C (30W)

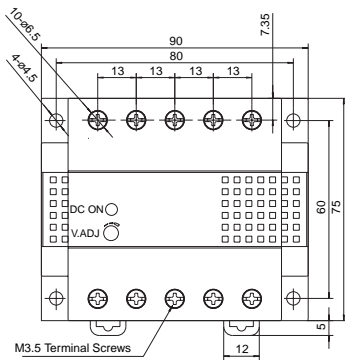

Height 75.0 mm
Width 90.0 mm
Depth 95.0 mm

PS5R-D (50W)

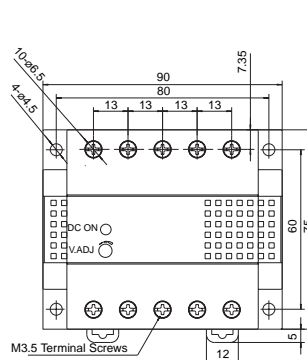

Height 75.0 mm
Width 90.0 mm
Depth 95.0 mm

PS5R-Q (75W)

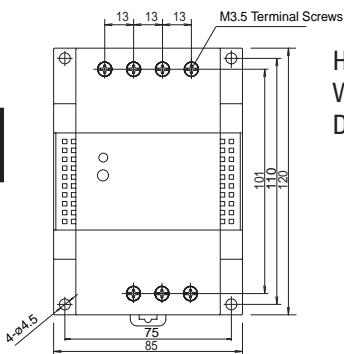

Height 120.0 mm
Width 85.0 mm
Depth 140.0 mm

PS5R-E (100W)

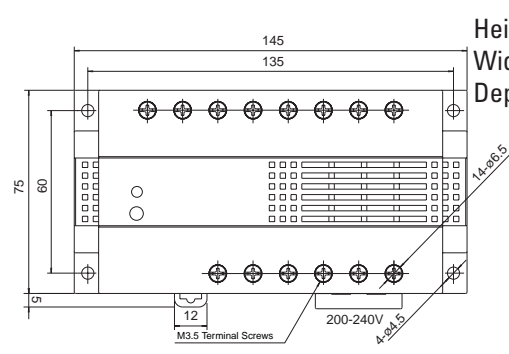

Height 75.0 mm
Width 145.0 mm
Depth 95.0 mm

PS5R-F (120W)

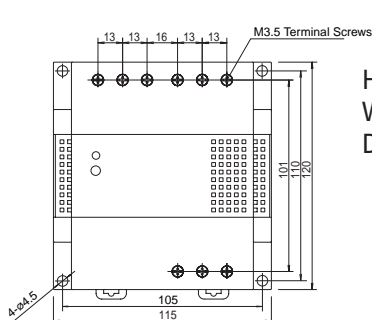

Height 120.0 mm
Width 115.0 mm
Depth 140.0 mm

PS5R-G (240W)

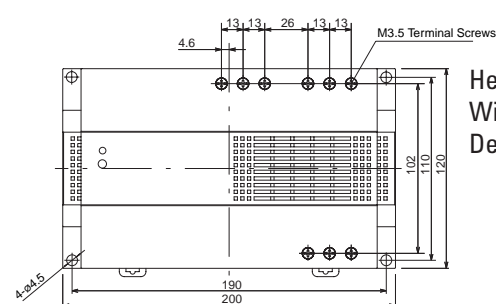

Height 120.0 mm
Width 200.0 mm
Depth 140.0 mm

Power Supplies

PS3L — Metal Frame Switching Power Supplies



Key features of the PS3L series include:

- Metal Frame
- Slim Style
- Wide Power Range: 10W-300W
- Universal Input:
10W-30W:85-264V AC/105-370V DC
50W-300W:85-264V AC/105-350V DC
- Screw Terminals, IP20 (fingersafe)
- Power Factor Correction
EN61000-3-2
EN61000-3-3 (50W to 300W models)
- Overcurrent/Overvoltage protection
- Voltage + 10% adjustment
- DIN rail or Panel Surface Mount
- Approvals:
CE marked
UL 508 listed
UL 1950 recognized
EN50178 compliant
EMC Directives
EN50081-2
EN61000-6-2
LVD
EN60950:2000



Part Numbers

Part Number	Item	Watts	Rated Voltage	Rated Current
PS3L-A05AFF		10	5V DC	2A
PS3L-A12AFF			12V DC	0.9A
PS3L-A24AFF			24V DC	0.5A
PS3L-B05AFF		15	5V DC	3A
PS3L-B12AFF			12V DC	1.4A
PS3L-B24AFF			24V DC	0.7A
PS3L-C05AFF		30	5V DC	6A
PS3L-C12AFF			12V DC	2.5A
PS3L-C24AFF			24V DC	1.3A
PS3L-D12AFF		50	12V DC	4.3A
PS3L-D24AFF			24V DC	2.2A
PS3L-E12AFF		100	12V DC	8.5A
PS3L-E24AFF			24V DC	4.5A
PS3L-F12AFF		150	12V DC	13A
PS3L-F24AFF			24V DC	6.5A
PS3L-G24AFF		300	24V DC	12.5A

Specifications

Type		PS3L-A (10W)	PS3L-B (15W)	PS3L-C (30W)	PS3L-D (50W)	PS3L-E (100W)	PS3L-F (150W)	PS3L-G24 (300W)		
Input	Input Voltage (Single-phase two-wire)	100 to 240V AC (Voltage range: 85 to 264V AC/105 to 370V DC)			100 to 240V AC (Voltage range: 85 to 264V AC/105 to 350V DC)					
	Frequency (AC input only)	47 to 63 Hz								
	Input Current (Typical)	100V	0.25A	0.37A	0.68A	0.68A	1.4A	2.0A	3.8A	
		200V	0.16A	0.23A	0.45A	0.34A	0.65A	0.95A	2.0A	
	Inrush Current (Cold start)	100V	20A max.	20A max.	20A max.	30A max.	30A max.	30A max.	30A max.	
		200V	40A max.	40A max.	40A max.	60A max.	60A max.	60A max.	60A max.	
	Leakage Current	0.75 mA max. (60Hz; UL, CSA, VDE)								
Power Factor (Typical)	—				0.99 (100V AC input, rated output), 0.95 (200V AC, rated output)					
Efficiency (Typical)	5V DC: 70%	5V DC: 73%	5V DC: 75%	—	—	—	—	—		
	12V DC: 74%	12V DC: 75%	12V DC: 77%	12V DC: 76%	12V DC: 78%	12V DC: 80%	—	—		
	24V DC: 78%	24V DC: 78%	24V DC: 79%	24V DC: 79%	24V DC: 81%	24V DC: 83%	24V DC: 81%	—		
Output	Rated Voltage/Current	5V/2A 12V/0.9A 24V/0.5A	5V/3A 12V/1.4A 24V/0.7A	5V/6A 12V/2.5A 24V/1.3A	— 12V/4.3A 24V/2.2A	— 12V/8.5A 24V/4.5A	— 12V/13A 24V/6.5A	— — 24V/12.5A		
	Adjustable Voltage Range	±10% (V.ADJ control on front)								
	Output Holding Time	20 msec minimum (at the rated input and output)								
	Start Time	200 msec maximum (at the rated input and output)				500 msec maximum (at the rated input and output)				
	Rise Time	100 msec maximum (at the rated input and output)				200 msec maximum (at the rated input and output)				
	Regulation	Input Fluctuation	5V: 20 mV maximum, 12V: 48 mV maximum, 24V: 96 mV maximum							
		Load Fluctuation	5V: 40 mV maximum, 12V: 100 mV maximum, 24V: 150 mV maximum							
		Temperature Change (-10 to +50°C)	5V	50 mV maximum	5V	60 mV maximum				
			12V	120 mV maximum	12V	150 mV maximum				
	Ripple Voltage	-10 to 0°C	5V: 160 mV maximum, 12V/24V: 180 mV maximum (Note 1)						200 mV maximum (Note 1)	
0 to +50°C		5V: 120 mV maximum, 12V/24V: 150 mV maximum (Note 1)								
Supplementary Functions	Overcurrent Protection	105% (Typical), Automatic reset (Note 2)								
	Overvoltage Protection	120% min. (Note 3)	Output off at 120%, reset when input voltage is restored. (Note 4)							
	Operation Indicator	Provided (Green LED)								
Dielectric Strength	Between input and output terminals:3,000V AC, 1 minute Between input terminal and housing:2,000V AC, 1 minute Between output terminal and housing:500V AC, 1 minute									
Insulation Resistance	Between input and output terminals:100MΩ minimum (500V DC megger) Between input terminal and housing:100MΩ minimum (500V DC megger)									
Operating Temperature (Note 5)	-10 to +70°C					-10 to +60°C		-10 to +65°C		
Storage Temperature	-30 to +75°C									
Operating Humidity	20 to 90% RH (no condensation, no freezing)									
Vibration Resistance	10 to 55 Hz, 20 m/s ² constant, sweep cycle 1 minute, 2 hours each in 3 axes									
Shock Resistance	200 m/s ² , 11 ms, 1 shock each in 3 axes									
Dimensions H X W X D (mm)	97 × 35 × 86	97 × 35 × 86	96 × 35 × 114.5	97 × 37 × 147.5	97 × 54 × 200	97 × 62 × 200	158 × 63 × 230			
Weight (Approx.)	240g	250g	340g	350g	630g	730g	1550g			
Terminal Screw	M4 slotted-Phillips head screw (screw terminal type)									



1. Including noise. Measured at the terminal block according to EIAJ.
2. Protection against short-circuit and overcurrent of 30 seconds maximum. Overload for 30 seconds or longer may damage the internal elements.
3. Zener limiter method
4. Turn the input off and after one minute, turn the input on again.
5. Refer to the derating characteristics. No freezing. The maximum temperature is the temperature at 100% output current (natural air-cooling) in the derating characteristics.

Characteristics

Operating Temperature vs. Output Current Characteristics (Derating Curves)

PS3L-A/B/C/D

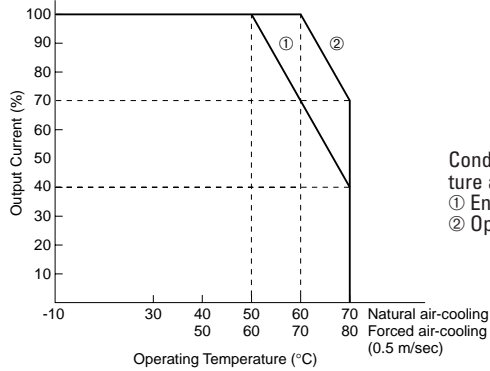

Conditions: At rated input/output (operating temperature is the temperature around the power supply)
 ① Enclosed (Mounting Directions A and B)
 ② Open frame (Mounting Directions A and B)

PS3L-E/F

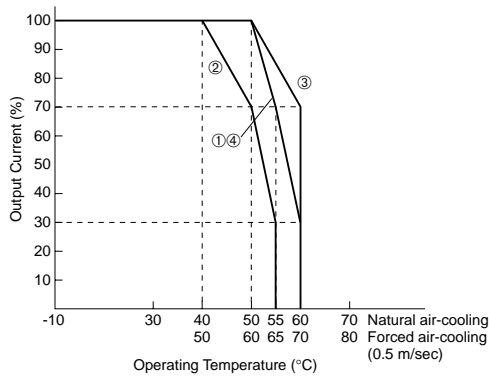

Conditions: At rated input/output (operating temperature is the temperature around the power supply)
 ① Enclosed (Mounting Direction A)
 ② Enclosed (Mounting Direction B)
 ③ Open frame (Mounting Direction A)
 ④ Open frame (Mounting Direction B)

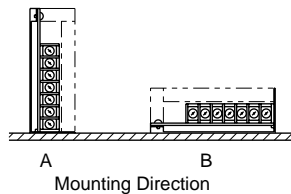

PS3L-G24

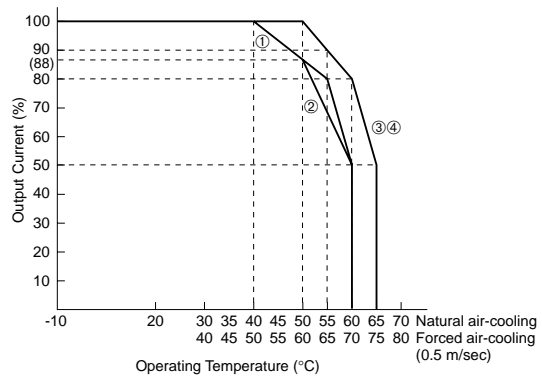

Conditions: At rated input/output (operating temperature is the temperature around the power supply)
 ① Enclosed (Mounting Direction A)
 ② Enclosed (Mounting Direction B)
 ③ Open frame (Mounting Direction A)
 ④ Open frame (Mounting Direction B)

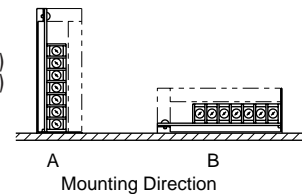

Overcurrent Protection Characteristics

PS3L-A/B

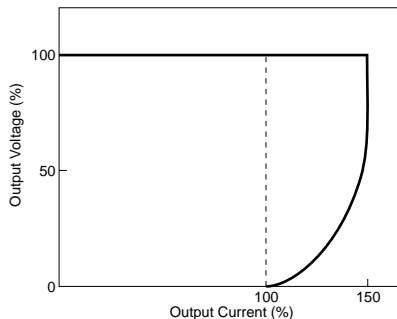

PS3L-C/D/E/F/G

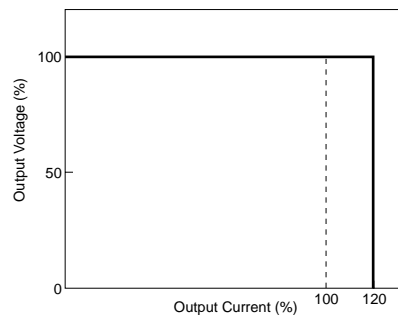

Internal Schematic Diagrams

PS3L-A/B/C

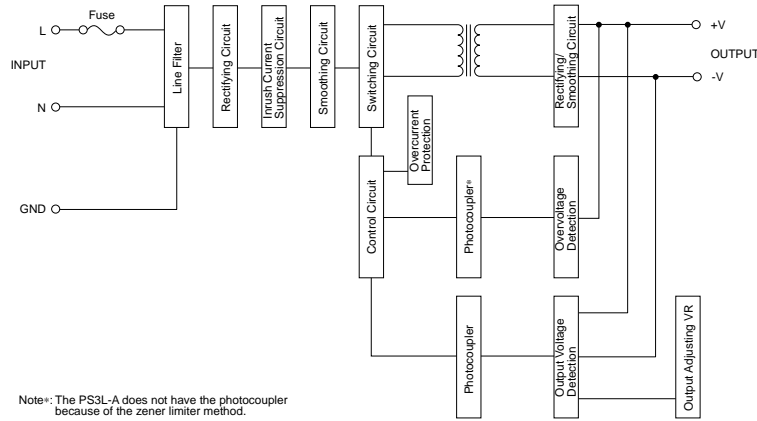

PS3L-D

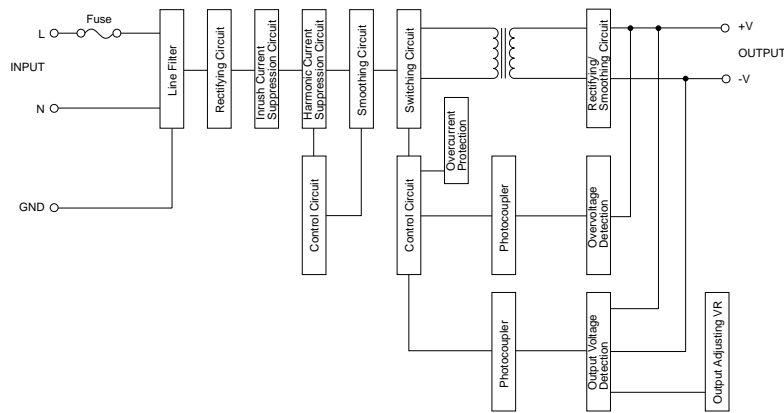

PS3L-E/F

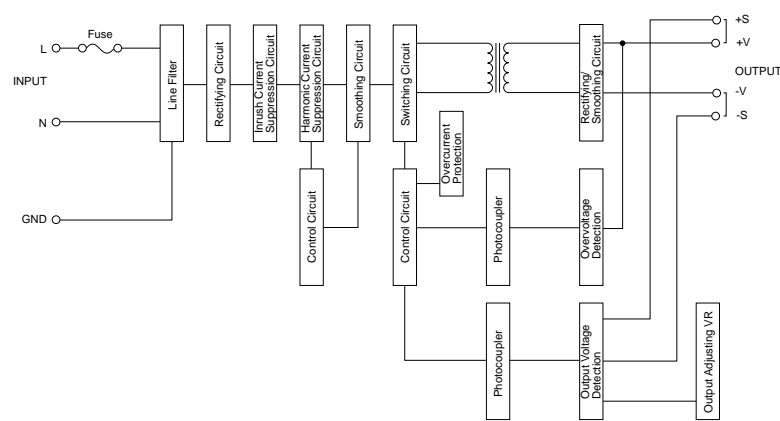

PS3L-G

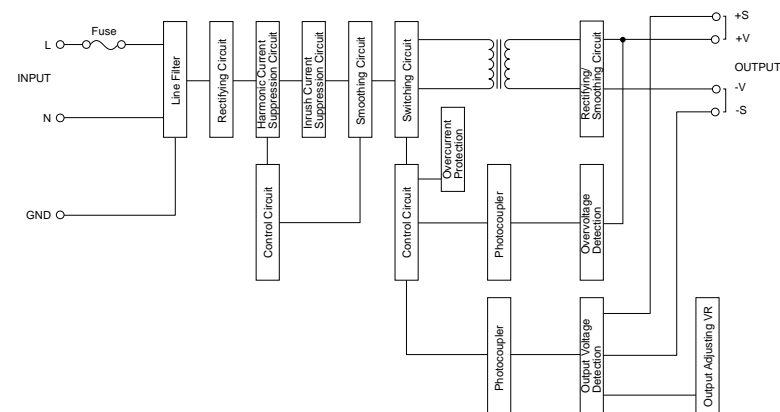

Terminal Markings

PS3L-A/B

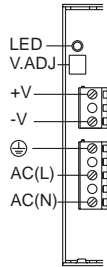

PS3L-C/D

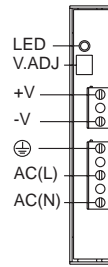

PS3L-E/F

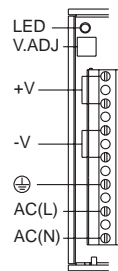

PS3L-G

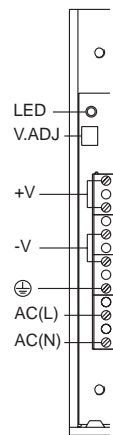

Marking	Name	Description
V.ADJ	Output Voltage Adjustment	Allows adjustment within $\pm 10\%$. Turning clockwise increases the output voltage.
LED	Operation Indicator (Green)	Lights on when the output voltage is on.
+V -V	DC Output Terminals	+V: Positive output terminal -V: Negative output terminal
⊕	Ground Terminal	Grounding the terminal reduces high-frequency currents caused by switching.
AC	Input Terminal	Accepts a wide range of voltage and frequency. Polarity is irrelevant when using a DC input.

Accessories

Mounting Bracket (Optional)

Model	Mounting Plate	L-shaped Bracket (1)	L-shaped Bracket (2)	Dimensions
PS3L-A/B	PS9Z-3E1B	PS9Z-3E2B	PS9Z-3E3B	See page L-19
PS3L-C	PS9Z-3E1C	PS9Z-3E2C	PS9Z-3E3C	
PS3L-D	PS9Z-3E1D	PS9Z-3E2D	PS9Z-3E3D	
PS3L-E	PS9Z-3L1F	PS9Z-3E2E	PS9Z-3E3E	
PS3L-F	PS9Z-3L1F	PS9Z-3E2F	PS9Z-3E3F	
PS3L-G	PS9Z-3L1G	—	—	

DIN-Rail Mounting Bracket (Optional)

Model	Part Number
PS3L-A	PS9Z-3E4C
PS3L-B	
PS3L-C	
PS3L-D	PS9Z-3E4D
PS3L-E	PS9Z-3E4F
PS3L-F	

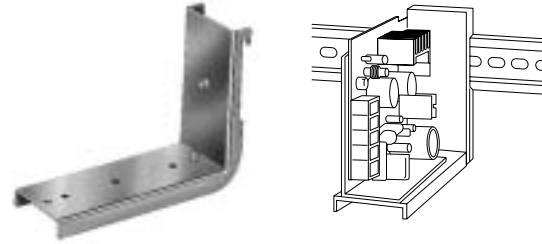

DIN-rail mounting brackets are ordered separately from switching power supplies.

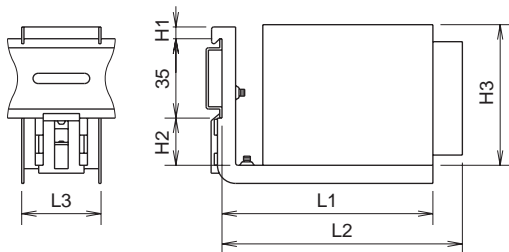

Part Number	Model	L1 (mm)	L2 (mm)	L3 (mm)	H1 (mm)	H2 (mm)	H3 (mm)
PS9Z-3E4C	PS3L-A	134	117	35	5.2	20.8	97
	PS3L-B						
	PS3L-C						
PS9Z-3E4D	PS3L-D	186	178.8	39.5	5.2	20.8	97
PS9Z-3E4F	PS3L-E	216.8	230.8	65	11.2	20	97
	PS3L-F						

Power Supplies

DIN Rail (Optional)

Part Number	Length	Material
BAA1000	1000 mm	Aluminum
BNDN1000	1000 mm	Aluminum

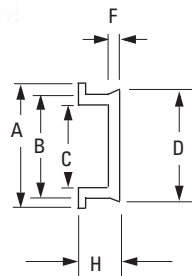
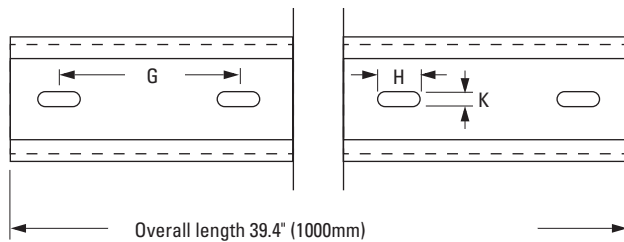

	Length in Inches (mm)
A	1.4" (35mm)
B	1.14" (29mm)
C	0.78" (23mm)
D	1.2" (31mm)
E	0.41" (10.5mm)
F	0.11" (3mm)
G	2" (51mm)
H	0.47" (12mm)
K	0.16" (4mm)

End Clip (Optional)

Item	Package No.
DIN Rail End Clip	BNL-5
	BNL-6

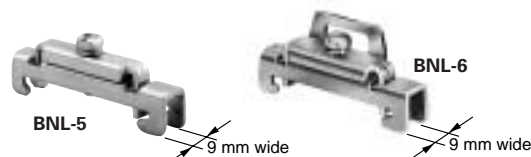

Installed on a DIN rail, the mounting clips prevent power supplies from sliding sideways.

Dimensions (tolerance: ±1 mm)

PS3L-A/B (10/15W)

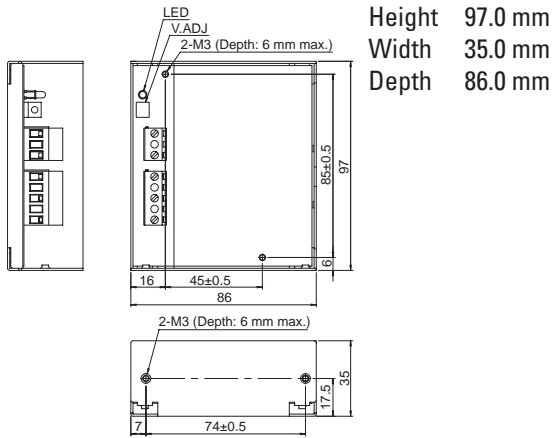

PS3L-C (30W)

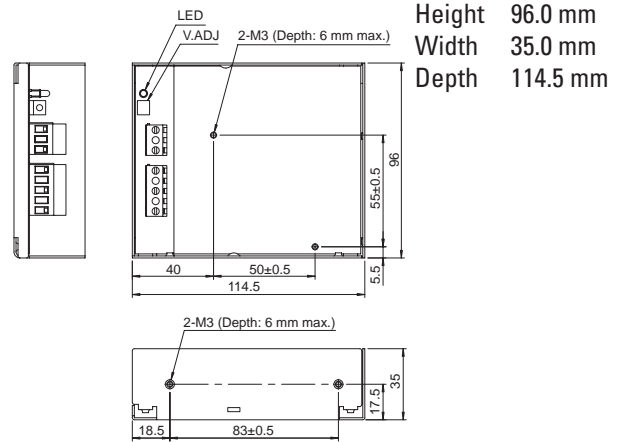

PS3L-D (50W)

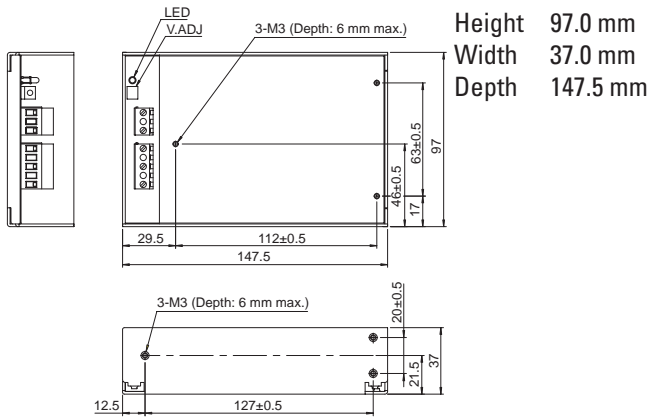

PS3L-E (100W)

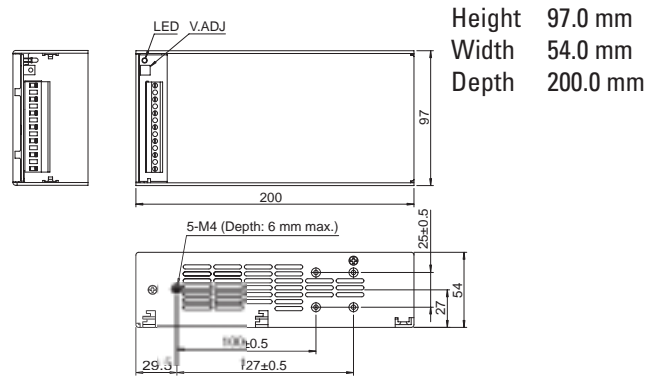

PS3L-F (150W)

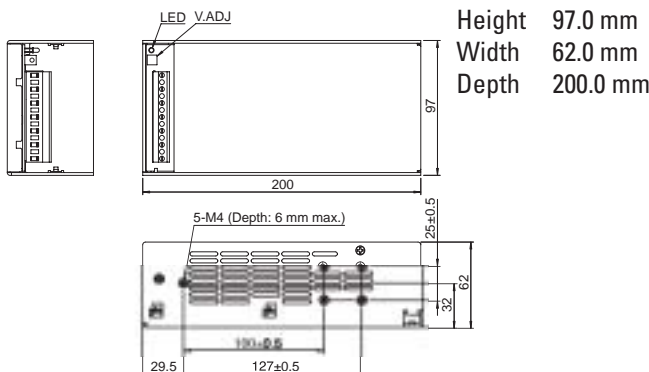

PS3L-G (300W)

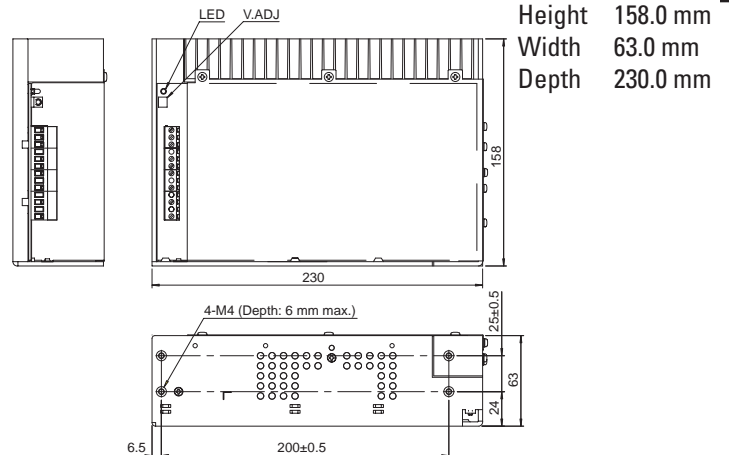

Make sure that the mounting screws do not penetrate into the power supply unit for 6 mm or more.

All dimensions in mm.

Mounting Bracket Dimensions (PS9Z-3E1/PS9Z-3E2/PS9Z-3E3/PS9Z-3L)

Mounting Plate

PS9Z-3E1B/3E1C
(For 10W/15W/30W Types)

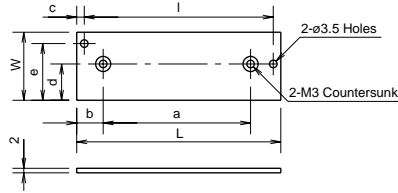

Part Number	Dimensions (mm)							
	W	L	l	a	b	c	d	e
PS9Z-3E1B	35	101	94	74	14.5	3.5	17.5	30
PS9Z-3E1C	33	138.5	128.5	83	32	5	17.5	26

L-shaped Bracket (1)

PS9Z-3E2B/3E2C
(For 10W/15W/30W Types)

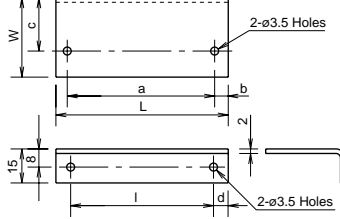

Part Number	Dimensions (mm)						
	W	L	l	a	b	c	d
PS9Z-3E2B	36	95.5	80.5	74	9.5	18.5	7.5
PS9Z-3E2C	38	118.5	104	83	15	20.5	7.5

L-shaped Bracket (2)

PS9Z-3E3B/3E3C
(For 10W/15W/30W Types)

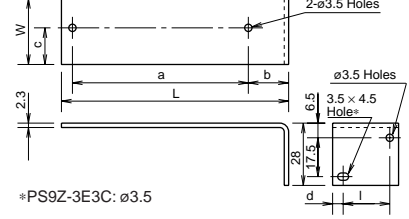

Part Number	Dimensions (mm)						
	W	L	l	a	b	c	d
PS9Z-3E3B	31	103	22.5	74	18	13.5	4.5
PS9Z-3E3C	33	126	25	83	21	15.5	4

PS9Z-3E1D
(For 50W Type)

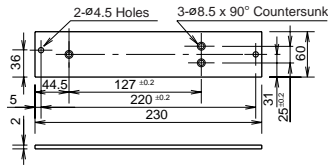

PS9Z-3E2D
(For 50W Type)

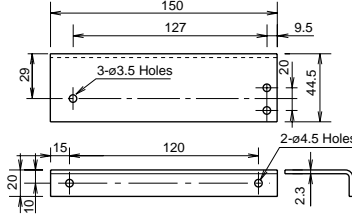

PS9Z-3E3D
(For 50W Type)

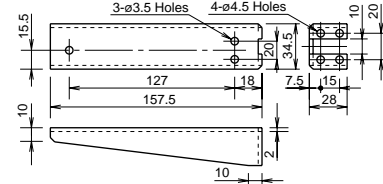

PS9Z-3L1F
(For 100W/150W Types)

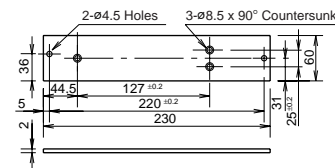

PS9Z-3E2E/3E2F
(For 100W/150W Types)

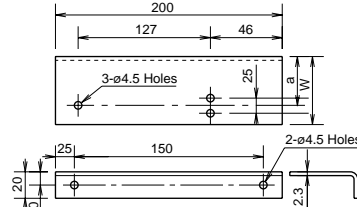

PS9Z-3E3E/3E3F
(For 100W/150W Types)

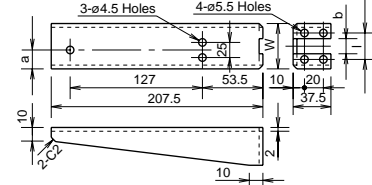

PS9Z-3L1G
(For 300W Type)

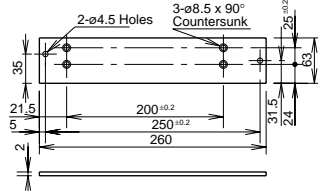

Part Number	Dimensions (mm)	
	W	a
PS9Z-3E2E	59	34.5
PS9Z-3E2F	70	40

Part Number	Dimensions (mm)			
	W	l	a	b
PS9Z-3E3E	54	32.5	27	12.5
PS9Z-3E3F	65	40	32.5	20

Power Supplies **L**

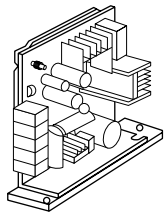

Mounting Hole Layout

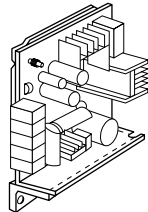
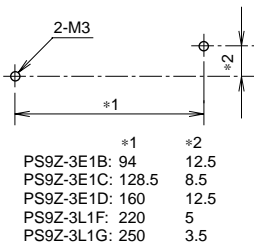

Mounting Hole Layout

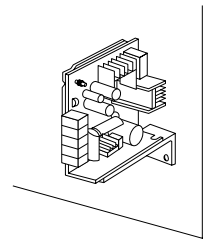
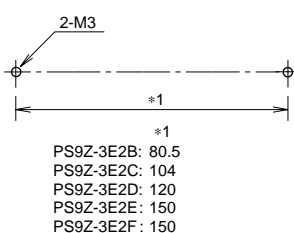

Mounting Hole Layout

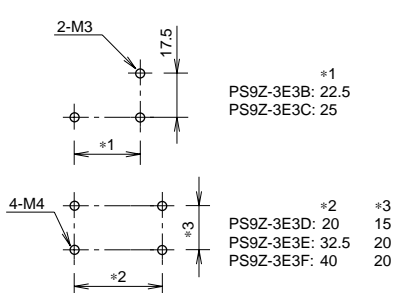

Installation

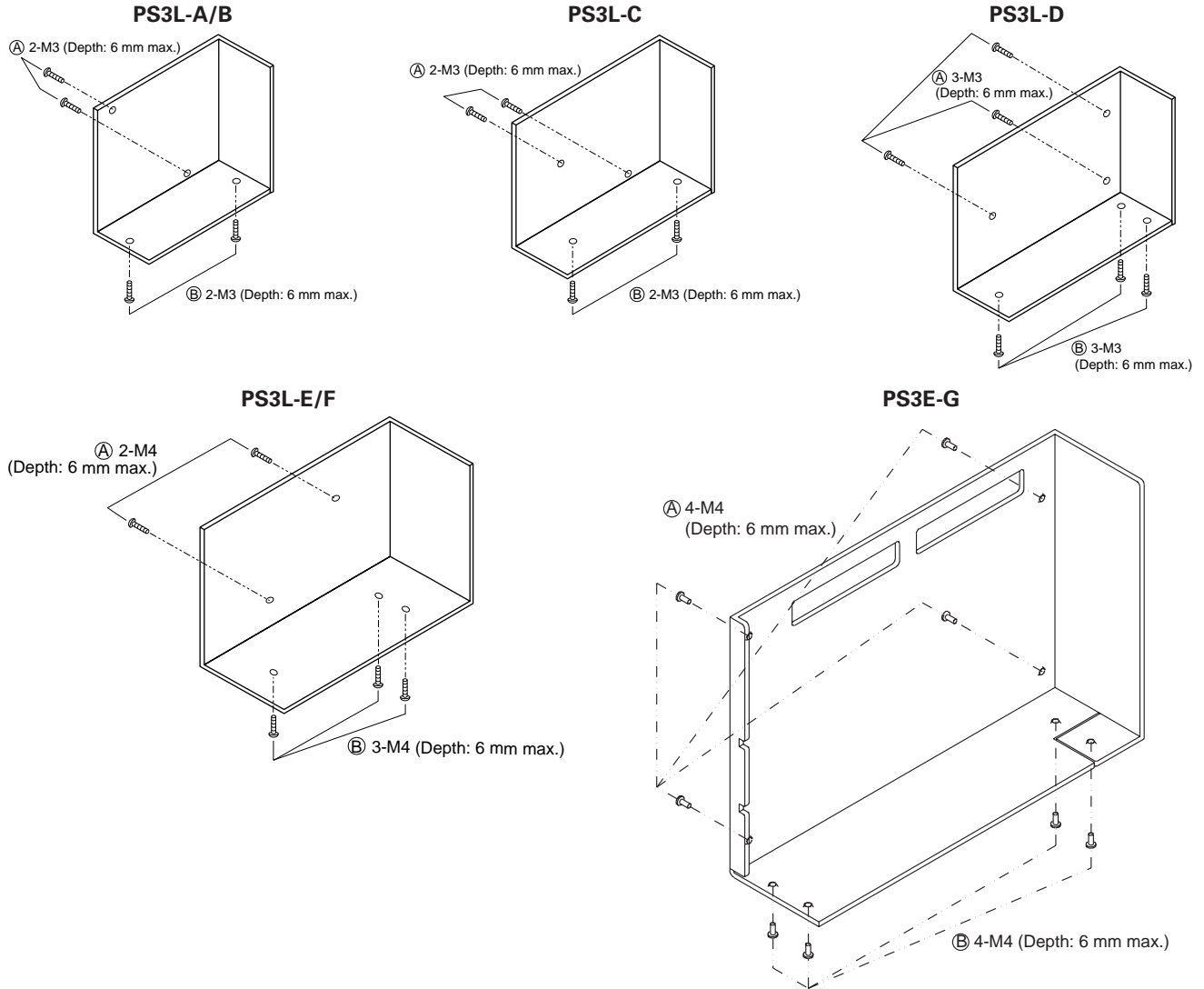

The figures above show the frames only. PC board and parts are omitted for illustration purposes.

Installation	Mounting Hole Layout				
	PS3L-A/B	PS3L-C	PS3L-D	PS3L-E/F	PS3L-G
A Side Mounting (screw from the back)					
B Side Mounting (screw from the back)					

Instructions

Notes for Installation

- PS3L switching power supplies can be installed in either (A) or (B) directions as shown below. For PS3L-E/F/G types, the operating temperature vs. output current characteristics vary with the mounting direction. See the derating curves on page L-15.

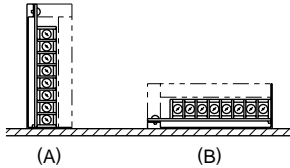

- Mount the switching power supply on a metallic surface that provides adequate heat dissipation. Be sure to prevent heat built-up around the power supplies.
- Maintain 20 mm clearance between the power supplies.

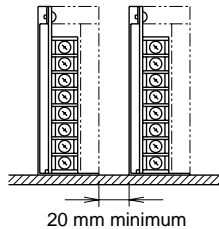

- Use mounting screws of a proper length so that screws do not penetrate into the housing of the switching power supply 6 mm or more.
- Mounting screws cannot be fastened on a PC board. Be sure to fasten the screws on the chassis side.

Overcurrent Protection

The output voltage drops automatically when an overcurrent flows due to an overload or short circuit. Normal voltage is automatically restored when the load returns to normal conditions.

Overvoltage Protection (PS3L-A)

The PS3L-A uses a Zener diode for overvoltage protection. In case overvoltage damages the zener diode, contact IDEC for repair. Do not apply an external overvoltage to the output terminal.

(PS3L-B/C/D/E/F/G)

The output is turned off by overvoltage protection when an overvoltage is applied. When the output voltage has dropped due to an overvoltage (120% or more), turn the input off, and after one minute, turn the input on again.

Series Operation

The following series operations are allowed.

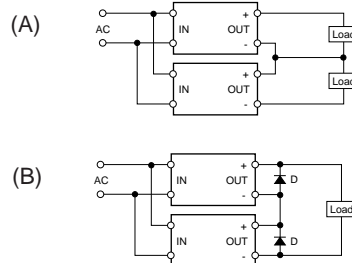

For the series operation (B), insert Schottky diodes D as shown in the figure. Select a Schottky diode in consideration of the rated current.

Notes for Operation

- Output interruption may indicate blown fuses. Contact IDEC.
- The internal fuse inside the power supply is for AC input. When using with DC input, install an external fuse for DC input. To avoid blown fuses, select fuses in consideration of the rated current of internal fuses.

Rated Current of Internal Fuses

Type No.	Rated Current of Fuse
PS3L-A	2A
PS3L-B	
PS3L-C	3.15A
PS3L-D	2A
PS3L-E	4A
PS3L-F	
PS3L-G	6.3A

- Avoid overload and short-circuit for a long period of time, otherwise the internal elements may be damaged.

4. Not suitable for parallel operation.

- DC input operation is not subject to safety standards.

Insulation/Dielectric Test

When conducting an insulation/dielectric test, short-circuit the input (between AC) and output (between + and -). Do not apply or interrupt the voltage suddenly, otherwise the surge voltage may be generated and the power supply may be damaged.

L

Adjustment of Output Voltage

The output voltage can be adjusted within $\pm 10\%$ of the rated output voltage by using the V.ADJ control on the front. Turning the V.ADJ clockwise increases the output voltage. When using a higher output voltage, reduce the output current to make sure that the output capacity is within the rating. Note that overvoltage protection may work when increasing the output voltage.

Safety Precautions

- Do not use switching power supplies with electric equipment whose malfunction or inadvertent operation may damage the human body or life directly.
- Make sure that the input voltage and output current do not exceed the ratings. If the input voltage and output current exceed the ratings, electric shock, fire, or malfunction may occur.
- Do not disassemble, repair, or modify the power supplies, otherwise the high voltage internal part may cause electric shock, fire, or malfunction.
- Do not touch the switching power supplies while input voltage is applied, otherwise electric shock may occur.
- Provide the final product with protection against malfunction or damage that may be caused by the malfunction of switching power supplies.
- Operating temperatures should not exceed the ratings. Be sure to note the derating characteristics. If the operating temperature exceeds the ratings, electric shock, fire, or malfunction may occur.
- Blown fuses indicate that the internal circuits are damaged. Contact IDEC for repair. Do not just replace the fuse and reoperate, otherwise electric shock, fire, or malfunction may occur.
- Do not use the switching power supplies to charge rechargeable batteries.